

AdStone Shower Trays

Colour:









White, Graphic, Black

Code:

STWQ1290 / STWQ1290L / STWQ90R (White)
 STAQ1290 / STAQ1290L / STAQ90R (Graphite)
 STBQ1290 / STBQ1290L / STBQ90R (Black)

Size: 1200mm x 900mm

Weight: 35kg

-  **CLASS 3**
ANTISLIP
CLASS 3
-  **EASY TO CUT**
-  **EASY TO CLEAN**
-  **CUSTOM MADE**
-  **IMPACT RESISTANT**
-  **ANTI-BACTERIAL**
-  **WATER PROOF**
-  **EASY TO REPAIR**
-  **QUALITY RAW MATERIAL**



Technical Information
 Offset Quad (1200 x 900mm)

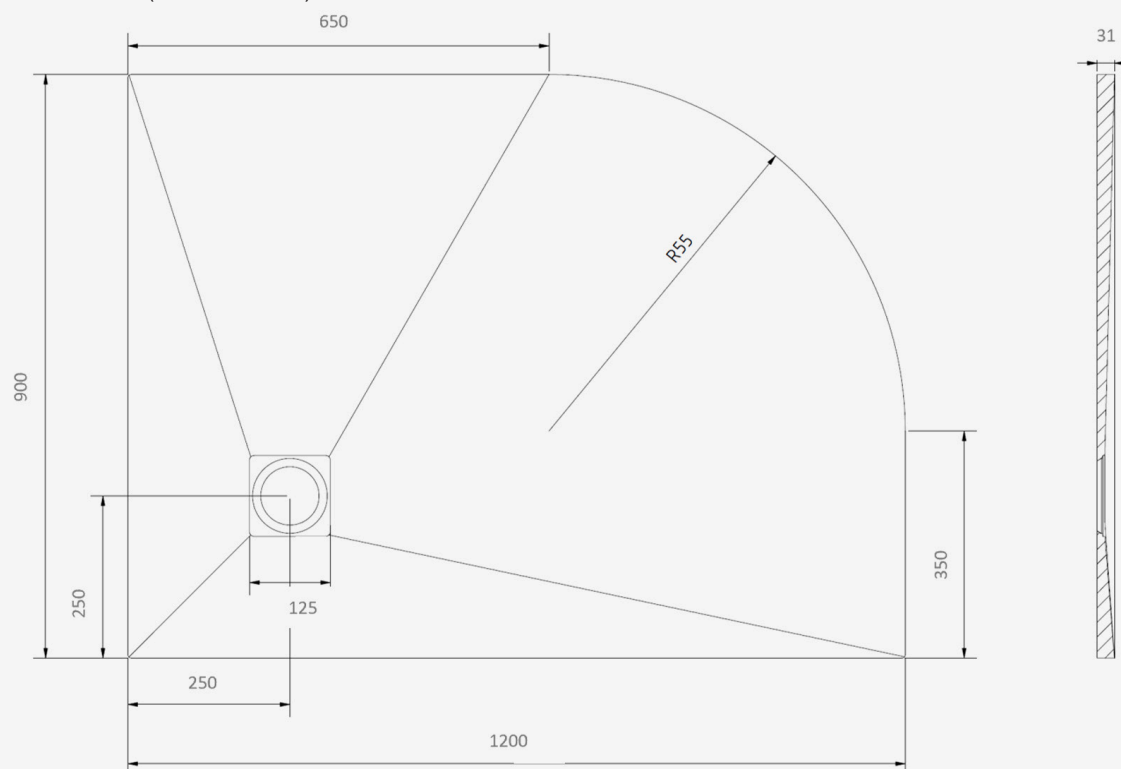

Founded 1880

Telephone 028 9081 7631
 Email info@adamsez.com

www.adamsez.com

 **AdColour;**
 Make me yours

