

AdStone Shower Trays

Colour:









White, Graphic, Black

Code:

STWR12090 / STWR14090 / STWR17090 (White)
 STAR12090 / STAR14090 / STAR17090 (Graphite)
 STBR12090 / STBR14090 / STBR17090 (Black)

Size: 900mm

Weight: 38 - 58kg

-  CLASS 3 ANTISLIP CLASS 3
-  EASY TO CUT
-  EASY TO CLEAN
-  CUSTOM MADE
-  IMPACT RESISTANT
-  ANTI-BACTERIAL
-  WATER PROOF
-  EASY TO REPAIR
-  QUALITY RAW MATERIAL



Technical Information
 Rectangle (900mm)

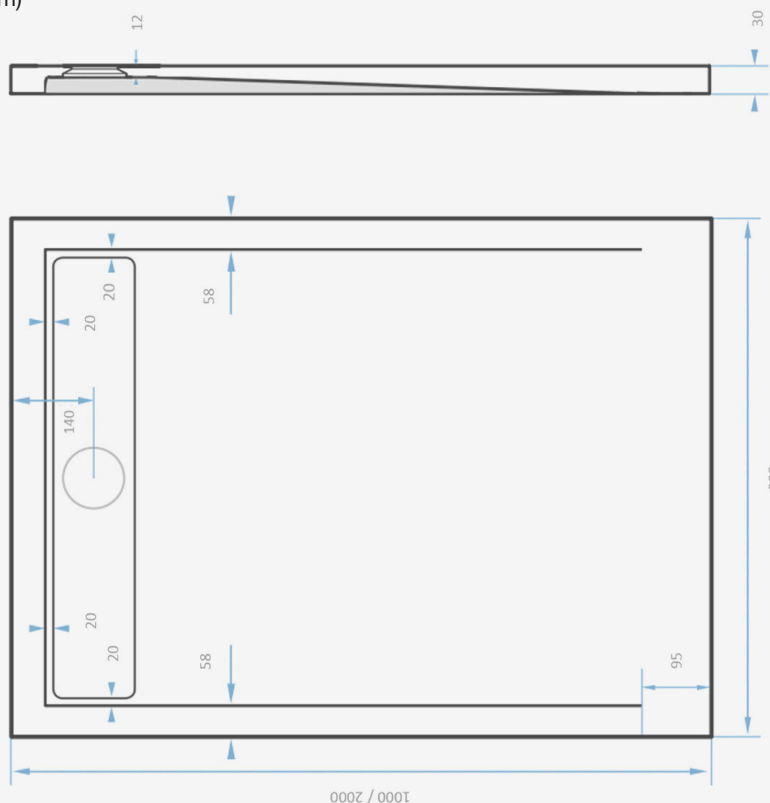

Founded 1880

Telephone 028 9081 7631
 Email info@adamsez.com

www.adamsez.com

 AdColour;
 Make me yours

