

AdStone Shower Trays

Colour:









White, Graphic, Black

Code:

STWR16070 / STWR17070 / STWR17080 / STWR14080 / STWR12080 (White)
 STAR16070 / STAR17070 / STAR17080 / STAR14080 / STAR12080 (Graphite)
 STBR16070 / STBR17070 / STBR17080 / STBR14080 / STBR12080 (Black)

Size: 700 / 900mm

Weight: 35 - 51kg

-  **CLASS 3**
ANTISLIP
CLASS 3
-  **EASY TO CUT**
-  **EASY TO CLEAN**
-  **CUSTOM MADE**
-  **IMPACT RESISTANT**
-  **ANTI-BACTERIAL**
-  **WATER PROOF**
-  **EASY TO REPAIR**
-  **QUALITY RAW MATERIAL**



Technical Information
 Rectangle (700 / 800mm)

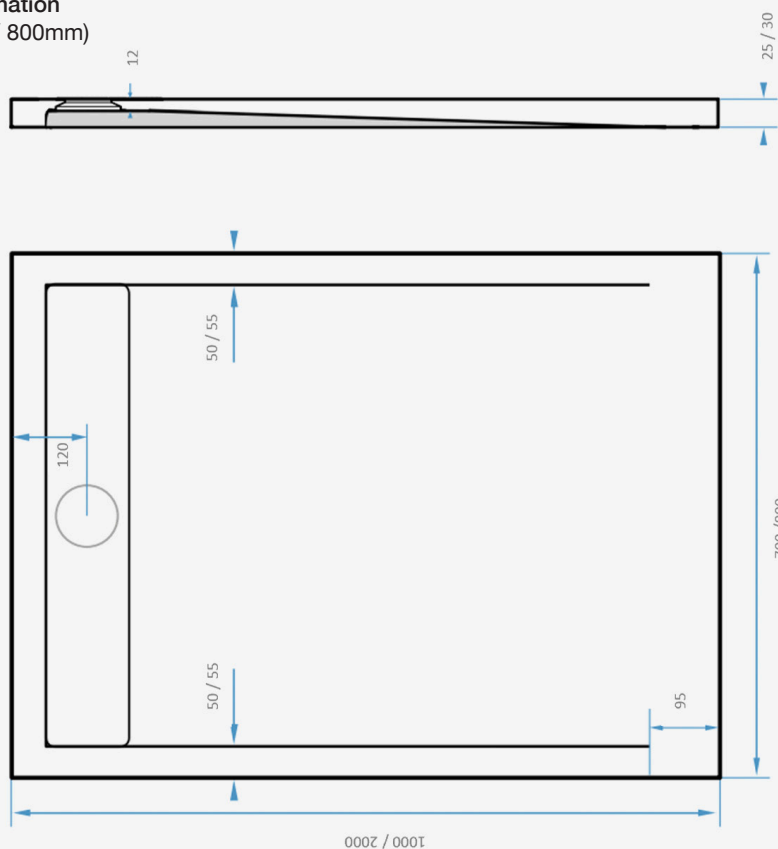

Founded
1880

Telephone 028 9081 7631
 Email info@adamsez.com

www.adamsez.com

 **AdColour;**
 Make me yours

