

AdStone Shower Trays

Colour:

White, Graphic, Black

Code:









STWR12090 / STWR14090 / STWR17090 / STWR10090 / STWR15090 /
STWR16090 / STWR18090 / STWR20090 / STWR10090 / STWR120100 /
STRWR15090 / STWR16090 / STWR18090 / STWR20090 / STWR200100 (White)

STAR12090 / STAR14090 / STAR17090 / STAR10090 / STAR120100 /
STAR15090 / STAR16090 / STAR18090 / STAR20090 / STAR200100 (Graphite)

STBR12090 / STBR14090 / STBR17090 / STBR10090 / STBR120100 /
STBR15090 / STBR16090 / STBR18090 / STBR20090 / STBR200100 (Black)

Size: 900mm

Weight: 38 - 72kg

-  CLASS 3 ANTISLIP CLASS 3
-  EASY TO CUT
-  EASY TO CLEAN
-  CUSTOM MADE
-  IMPACT RESISTANT
-  ANTI-BACTERIAL
-  WATER PROOF
-  EASY TO REPAIR
-  QUALITY RAW MATERIAL



Technical Information
Rectangle (900mm)

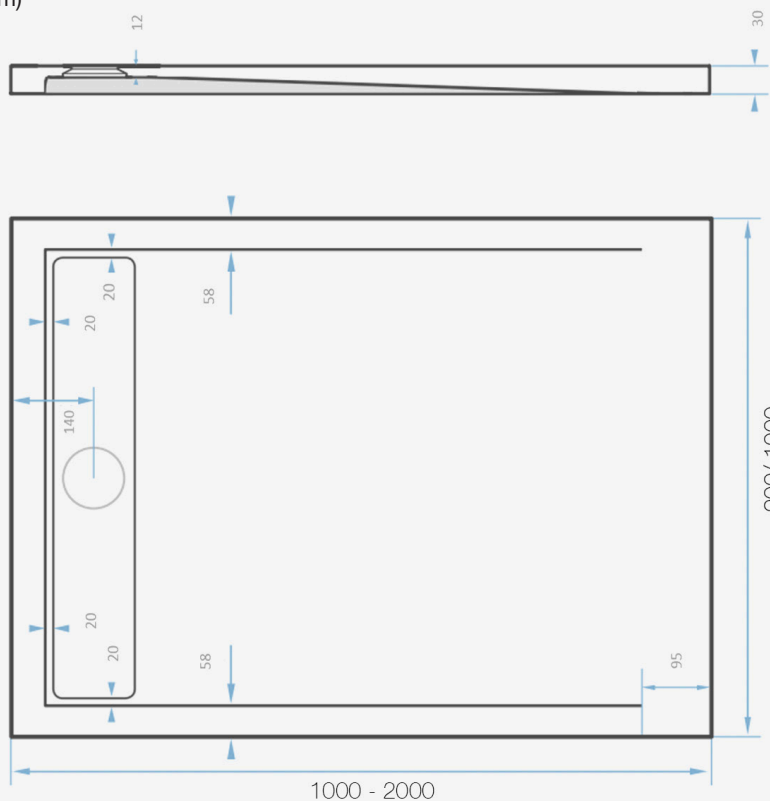

Founded
1880

Telephone 028 9081 7631
Email info@adamsez.com

www.adamsez.com

 AdColour;
Make me yours

