

AdVance - Acrylic

Sonata

Back-to-Wall 1700

Code: SONB2W/170X80

Technical Information

Size: 1700 x 800mm

Weight: 58kg

Estimate Volume: 302L

Lifetime Guarantee (T&Cs Apply)

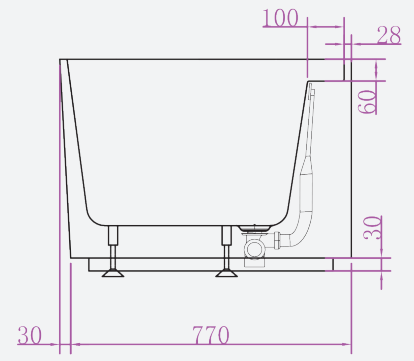
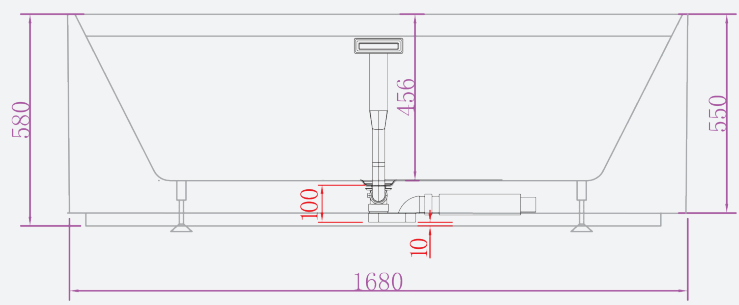
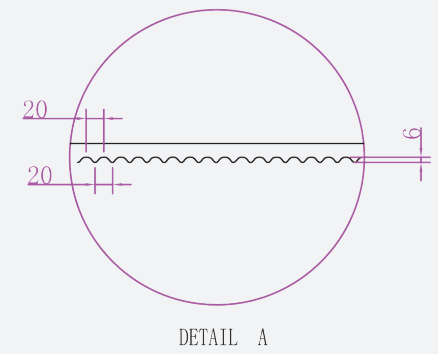
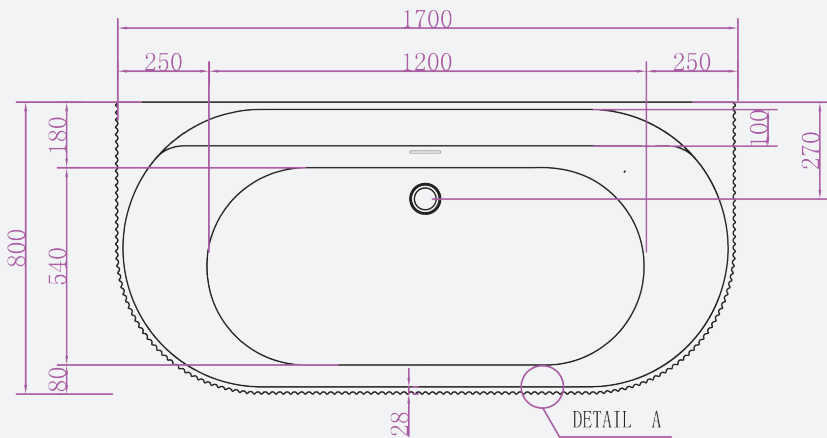

Founded
1880

Telephone 028 9081 7631
Email info@adamsez.com

www.adamsez.com

