

Ancillaries

Lux End Panel

Code: EP/700LUX

Technical Information

Size: 700mm

5mm Standard Panel

12-Year Guarantee (T&Cs Apply)

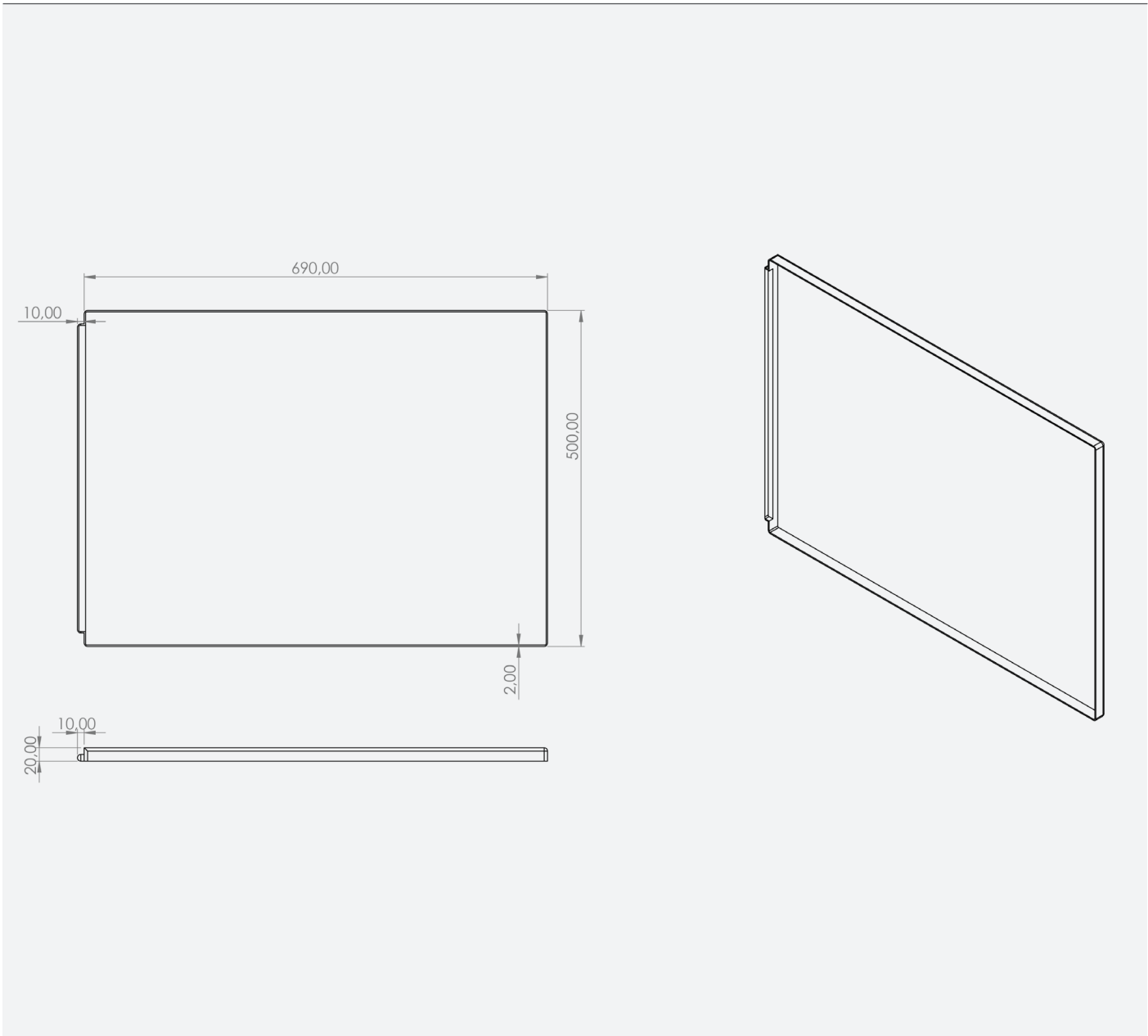

Founded
1880

Telephone 028 9081 7631
Email info@adamsez.com

www.adamsez.com

 AdColour;
Make me yours

